



DS 200

Electronic Pressure Switch

Stainless Steel Sensor

accuracy according to IEC 60770:
standard: 0.35 % FSO
option: 0.25 % FSO

Nominal pressure

from 0 ... 100 mbar up to 0 ... 600 bar

Contacts

1, 2 or 4 independent PNP contacts,
freely configurable

Analogue output

2-wire: 4 ... 20 mA
3-wire: 4 ... 20 mA / 0 ... 10 V
others on request

Special characteristics

- ▶ indication of measured values
on a 4-digit LED display
- ▶ rotatable and configurable
display module

Optional versions

- ▶ **IS-version**
Ex ia = intrinsically safe for gases
- ▶ pressure sensor welded
- ▶ customer specific versions



The electronic pressure switch DS 200 is the
successful combination of

- ▶ intelligent pressure switch
- ▶ digital display

and has been specially designed for numerous
applications in various industrial sectors.

As standard the DS 200 offers a PNP contact
and a rotatable display module with 4-digit
LED display. Optional versions like e.g. an
intrinsically safe version, max. four contacts and
an analogue output complete the profile.

Preferred areas of use are

-  Plant and machine engineering
-  Heating and air conditioning
-  Environmental engineering
(water – sewage – recycling)



Input pressure range												
Nominal pressure gauge ¹ [bar]	-1...0	0.10	0.16	0.25	0.40	0.60	1	1.6	2.5	4	6	
Nominal pressure absolute [bar]	-	-	-	-	0.40	0.60	1	1.6	2.5	4	6	
Level gauge ¹ [mH ₂ O]	-	1	1.6	2.5	4	6	10	16	25	40	60	
Overpressure [bar]	5	0.5	1	1	2	5	5	10	10	20	40	
Burst pressure ≥ [bar]	7.5	1.5	1.5	1.5	3	7.5	7.5	15	15	25	50	

Nominal pressure gauge ¹ / abs. [bar]	10	16	25	40	60	100	160	250	400	600	
Level gauge ¹ [mH ₂ O]	100	160	250	400	600	-	-	-	-	-	
Overpressure [bar]	40	80	80	105	210	210	600	1000	1000	1000	
Burst pressure ≥ [bar]	50	120	120	210	420	420	1000	1250	1250	1250	
Vacuum resistance	p _N ≥ 1 bar: unlimited vacuum resistance; p _N < 1 bar: on request										
¹ from 60 bar: measurement starts with ambient pressure											

Contact ²	
Standard	1 PNP contact
Options	2 independent PNP contacts 4 independent PNP contacts (possible with M12x1, 8-pin for 4 ... 20 mA/3-wire; 0 ... 10 V/3-wire on request)
Max. switching current	4 ... 20 mA / 2- and 3-wire: contact rating 125 mA, short-circuit resistant; V _{switch} = V _S - 2V 0 ... 10 V / 3-wire: contact rating 125 mA, short-circuit resistant
Accuracy of contacts ³	standard: p _N < 0.4 bar: ≤ ± 0.5 % FSO p _N ≥ 0.4 bar: ≤ ± 0.35 % FSO option: p _N ≥ 0.4 bar: ≤ ± 0.25 % FSO
Repeatability	≤ ± 0.1 % FSO
Switching frequency	max. 10 Hz
Switching cycles	> 100 x 10 ⁶
Delay time	0 ... 100 sec

² max. 1 contact for 2-wire current signal with plug ISO 4400 as well as 2-wire current signal with IS-protection
no contact possible with 3-wire in combination with plug ISO 4400

Analogue output (optionally) / Supply	
2-wire current signal	4 ... 20 mA / V _S = 13 ... 36 V _{DC} permissible load: R _{max} = [(V _S - V _{S min}) / 0.02 A] Ω response time: < 10 msec
2-wire current signal with IS-protection	4 ... 20 mA / V _S = 15 ... 28 V _{DC} permissible load: R _{max} = [(V _S - V _{S min}) / 0.02 A] Ω response time: < 10 msec
3-wire current signal	4 ... 20 mA / V _S = 19 ... 30 V _{DC} adjustable (turn-down of span 1:5) ⁴ permissible load: R _{max} = 500 Ω response time: < 3 sec
3-wire voltage signal	0 ... 10 V / V _S = 15 ... 36 V _{DC} permissible load: R _{min} = 10 kΩ response time: < 3 msec
without analogue output	V _S = 15 ... 36 V _{DC}
Accuracy ³	standard: p _N < 0.4 bar: ≤ ± 0.5 % FSO; p _N ≥ 0.4 bar: ≤ ± 0.35 % FSO option: p _N ≥ 0.4 bar: ≤ ± 0.25 % FSO

³ accuracy according to IEC 60770 – limit point adjustment (non-linearity, hysteresis, repeatability)

⁴ with turn-down of span the analogue signal is adjusted automatically to the new measuring range

Thermal effects (offset and span)			
Nominal pressure p _N [bar]	-1 ... 0	< 0.40	≥ 0.40
Tolerance band [% FSO]	≤ ± 0.75	≤ ± 1	≤ ± 0.75
in compensated range [°C]	-20 ... 85	0 ... 70	-20 ... 85

Permissible temperatures	
Medium	-40 ... 125 °C
Electronics / environment	-40 ... 85 °C
Storage	-40 ... 100 °C

Electrical protection	
Short-circuit protection	permanent
Reverse polarity protection	no damage, but also no function
Electromagnetic compatibility	emission and immunity according to EN 61326

Mechanical stability	
Vibration	10 g RMS (25 ... 2000 Hz) according to DIN EN 60068-2-6
Shock	500 g / 1 msec according to DIN EN 60068-2-27

Materials	
Pressure port	stainless steel 1.4404 (316 L)
Housing	stainless steel 1.4404 (316 L)
Display housing	PA 6.6, polycarbonate
Seals (media wetted)	standard: FKM option: welded version ⁵ others on request
Diaphragm	stainless steel 1.4435 (316 L)
Media wetted parts	pressure port, seals, diaphragm

⁵ welded version only for pressure ports according to EN 837 and NPT; possible for nominal pressure ranges p_N ≤ 40 bar

Electrical connections (dimensions mm / in)

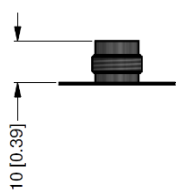

M12x1 plastic
(5-pin)

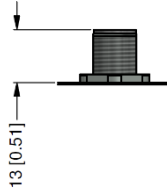

M12x1 metal
(5-pin)

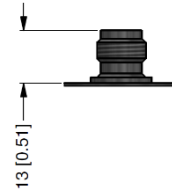

M12x1 plastic
(8-pin)

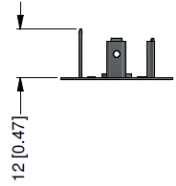

ISO 4400

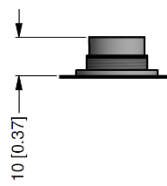

Binder series 723
(5-pin)

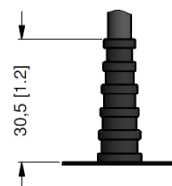

cable outlet⁹

⁹ different cable types and lengths available; permissible temperature depends on kind of cable;
standard: 2 m PVC cable (without ventilation tube, permissible temperature: -5 ... 70 °C)

Dimensions (mm / in)

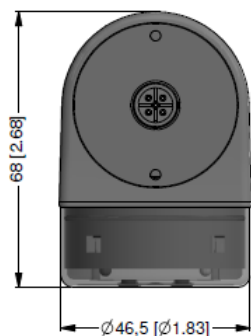
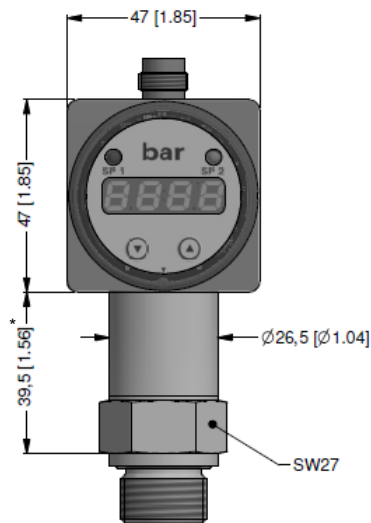

rotatability of display module



* for nominal pressure $p_N > 400$ bar increases the length of device by 19 mm (without explosion protection) or by 39 mm (with explosion protection)

Mechanical connection (dimensions mm / in)

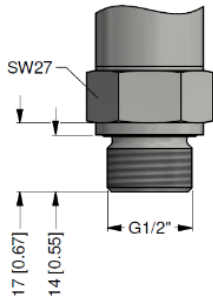

G1/2" DIN 3852

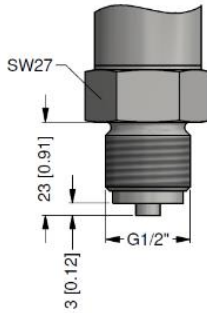

G1/2" EN 837

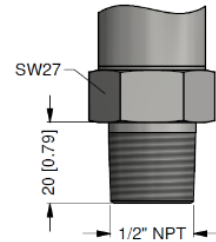

1/2" NPT

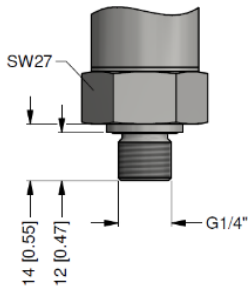

G1/4" DIN 3852

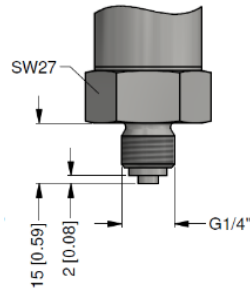

G1/4" EN 837

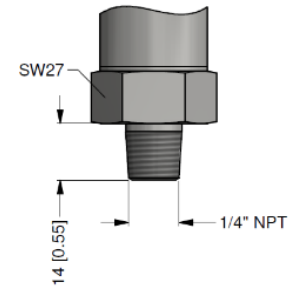

1/4" NPT

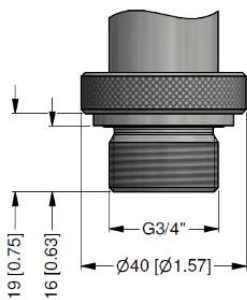

G3/4" flush DIN 3852
(0.1 bar ≤ p_N ≤ 40 bar)

length of device: 87.5 mm (without plug)

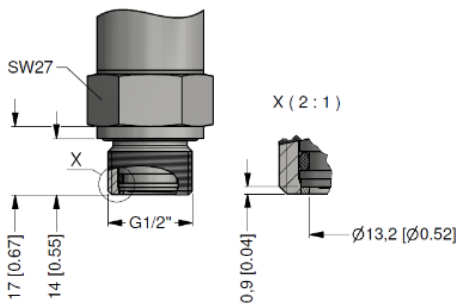

G1/2" flush DIN 3852
(0.1 bar ≤ p_N ≤ 40 bar)

length of device: 103 mm (without plug)

⇒ metric threads and other versions on request

© 2023 BD|SENSORS GmbH – The specifications given in this document represent the state of engineering at the time of publishing. We reserve the right to make modifications to the specifications and materials.

