



DS 401

Intelligent Electronic Pressure Switch Stainless Steel

Ceramic Sensor

accuracy according to IEC 60770:
0.5 % FSO

Nominal pressure

from 0 ... 400 mbar up to 600 bar

Contacts

1 or 2 independent PNP contacts,
freely configurable

Analogue output

2-wire: 4 ... 20 mA

3-wire: 4 ... 20 mA

others on request

Special characteristics

- ▶ indication of measured values on a 4-digit LED display
- ▶ rotatable and configurable display module

Optional versions





- ▶ **IS-version**
Ex ia = intrinsically safe for gases and dust
- ▶ pressure port PVDF
- ▶ customer specific versions

The electronic pressure switch DS 401 is the successful combination of

- ▶ intelligent pressure switch
- ▶ digital display

and has been specially designed for universal usage in industry applications; with flush diaphragm the DS 401 is suitable for the usage in viscous, pasty or highly contaminated media. The rotatable stainless steel globe housing is predestined for rough conditions and difficult installing conditions, caused by the high functionality and robustness. As standard the DS 401 offers a PNP contact and is optionally available with a second, independent contact. Additionally the DS 401 could be equipped with an analogue output.

Preferred areas of use are

-  Plant and machine engineering
-  Environmental engineering
(water – sewage – recycling)
-  Water
-  Hydraulic oil



Input pressure ranges																		
Nominal pressure gauge [bar]	-1...0	0.4	0.6	1	1.6	2.5	4	6	10	16	25	40	60	100	160	250	400	600
Nominal pressure abs. [bar]	-	-	0.6	1	1.6	2.5	4	6	10	16	25	40	60	100	160	250	400	600
Level gauge [mH ₂ O]	-	4	6	10	16	25	40	60	100	160	250	400	600	-	-	-	-	-
Overpressure [bar]	4	1	2	2	4	4	10	10	20	40	40	100	100	200	400	400	600	800
Burst pressure ≥ [bar]	7	2	4	4	5	5	12	12	25	50	50	120	120	250	500	500	650	880
Vacuum resistance	p _N ≥ 1 bar: unlimited vacuum resistance p _N < 1 bar: on request																	
Contact ¹																		
Number, type	standard: 1 PNP contact option: 2 independent PNP contacts																	
Max. switching current	contact rating 125 mA, short-circuit resistant; V _{Switch} = V _S - 2V																	
Accuracy of contacts ²	≤ ± 0.5 % FSO																	
Repeatability	≤ ± 0.2 % FSO																	
Switching frequency	2-wire: max. 10 Hz / 3-wire: 50 Hz																	
Switching cycles	> 100 x 10 ⁶																	
Delay time	0 ... 100 sec																	
¹ with Ex-protection max. 1 contact possible																		
Analogue output (optionally) / Supply																		
2-wire current signal	4 ... 20 mA / V _S = 13 ... 36 V _{DC} permissible load: R _{max} = [(V _S - V _{S min}) / 0.02 A] Ω response time: < 10 msec																	
2-wire current signal, IS-protection	4 ... 20 mA / V _S = 15 ... 28 V _{DC} permissible load: R _{max} = [(V _S - V _{S min}) / 0.02 A] Ω response time: < 10 msec																	
3-wire current signal	4 ... 20 mA / V _S = 24 V _{DC} ± 10 % adjustable (turn-down of span 1:5) ³ permissible load: R _{max} = 500 Ω response time: < 30 msec																	
Without analogue output	V _S = 15 ... 36 V _{DC}																	
Accuracy ²	≤ ± 0.5 % FSO																	
² accuracy according to IEC 60770 – limit point adjustment (non-linearity, hysteresis, repeatability)																		
³ with turn-down of span the analogue signal is adjusted automatically to the new measuring range																		
Thermal effects (offset and span)																		
Thermal error	≤ ± 0.2 % FSO / 10 K																	
in compensated range	0 ... 85 °C																	
Permissible temperatures																		
Medium ⁴	-40 ... 125 °C																	
Electronics / environment	-40 ... 85 °C																	
Storage	-40 ... 100 °C																	
⁴ for pressure port in PVDF the medium temperature is -30 ... 60 °C																		
Electrical protection																		
Short-circuit protection	permanent																	
Reverse polarity protection	no damage, but also no function																	
Electromagnetic compatibility	emission and immunity according to EN 61326																	
Mechanical stability																		
Vibration	10 g RMS (25 ... 2000 Hz) according to DIN EN 60068-2-6																	
Shock	500 g / 1 msec according to DIN EN 60068-2-27																	
Materials																		
Pressure port	standard: 1.4404 (316L) option for G1/2" open port (up to 60 bar): PVDF																	
Housing	stainless steel 1.4301 (304)																	
Housing cap	standard: plastic HDPE for option IS-protection: stainless steel 1.4301 (304)																	
Viewing glass	laminated safety glass																	
Seals	standard: FKM option: EPDM (p _N ≤ 160 bar) others on request																	
Diaphragm	ceramics Al ₂ O ₃ 96 %																	
Media wetted parts	pressure port, seals, diaphragm																	
Explosion protection (only for 4 ... 20 mA / 2-wire)																		
Approval AX14-DS 401	IBExU06ATEX1050 X zone 0: II 1G Ex ia IIC T4 Ga zone 20: II 1D Ex ia IIIC T135 °C Da																	
Safety technical maximum values	U _i = 28 V, I _i = 93 mA, P _i = 660 mW, C ≈ 0 nF, L _i ≈ 0 μH																	
Max. switching current ⁵	70 mA																	
Permissible temperatures for environment	in zone 0: -20 ... 60 °C with p _{atm} 0.8 bar up to 1.1 bar in zone 1 or higher: -25 ... 70 °C																	
⁵ the real switching current in the application depends on the power supply unit																		

Miscellaneous	
Display	4-digit, 7-segment-LED display; visible range 37.2 x 11 mm; digit height 10 mm, range of indication -1999 ... +9999; accuracy 0.1 % ± 1 digit digital damping 0.3 ... 30 sec (programmable) measured value update 0.0 ... 10 sec (programmable)
Option oxygen application ⁶	for $p_N \leq 25$ bar: O-ring in FKM Vi 567 (with BAM-approval); permissible maximum values are 25 bar / 150° C
Current consumption (without contacts)	2-wire signal output current: max. 25 mA 3-wire signal output current: approx. 30 mA + signal current
Ingress protection	IP 67
Installation position	any
Weight	approx. 400 g
Operational life	100 million load cycles
CE-conformity	EMC Directive: 2014/30/EU Pressure Equipment Directive: 2014/68/EU (module A) ⁷
ATEX Directive	2014/34/EU

⁶ not possible with flush pressure ports

⁷ This directive is only valid for devices with maximum permissible overpressure > 200 bar

Wiring diagrams

2-wire-system (current)

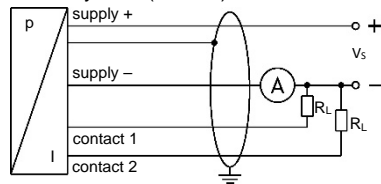

3-wire-system (current)

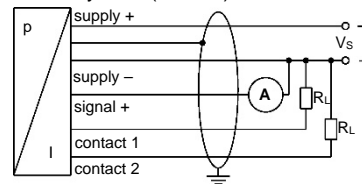

Pin configuration

Electrical connection	M12x1 / metal (5-pin)	
Supply +	1	
Supply -	3	
Signal + (only 3-wire)	2	
Contact 1	4	
Contact 2	5	
Shield	plug housing / pressure port	

Dimensions (mm / in)

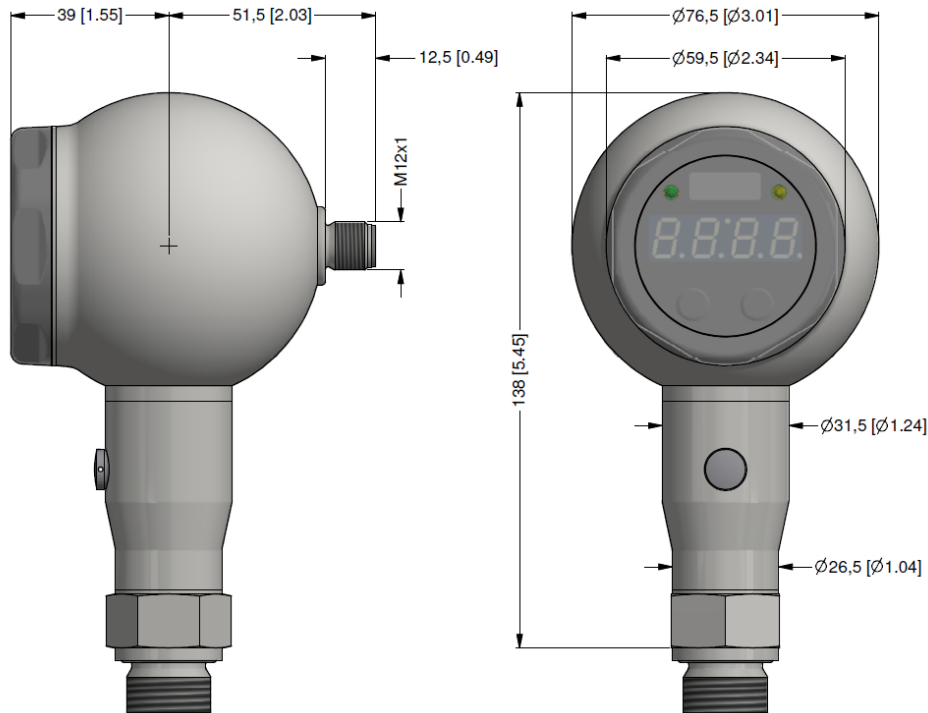

Mechanical connections (dimensions mm / in)

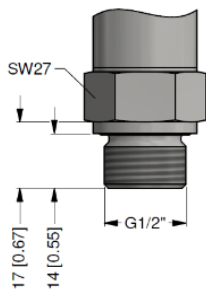

G1/2" DIN 3852

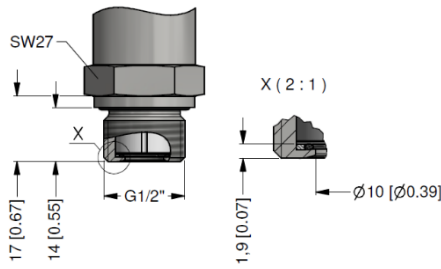

G1/2" semi-flush DIN 3852
(p_N from 0.4 up to 60 bar)

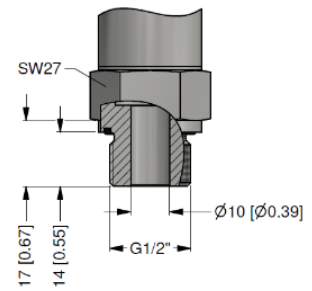

G1/2" open port
DIN 3852

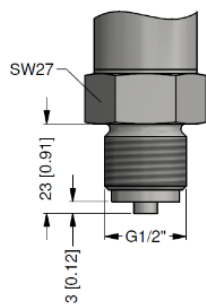

G1/2" EN 837

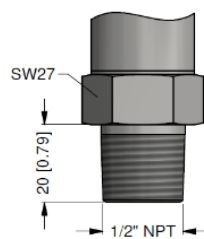

1/2" NPT

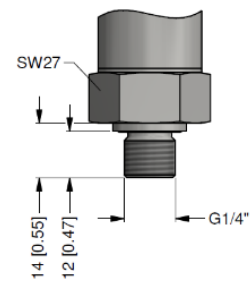

G1/4" DIN 3852

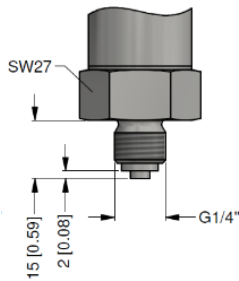

G1/4" EN 837

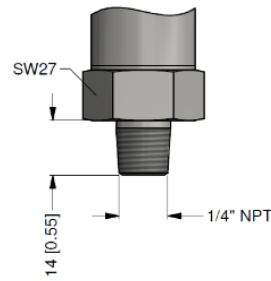

1/4" NPT

⇨ metric threads and other versions on request

Designs ⁸

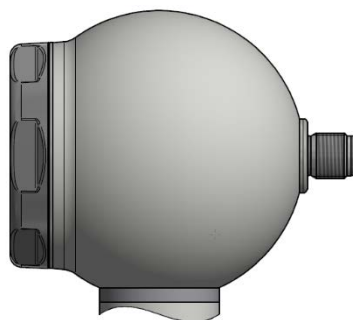

side display



45° display (on request)

⁸ all designs in horizontal rotatable housing as standard

Ordering code DS 401

DS 401

Pressure																		
	gauge		7	A	2													
	gauge in mH ₂ O		7	A	E													
	absolute		7	A	3													
Input																		
	[mH ₂ O]	[bar]																
	4	0.4	4	0	0	0												
	6	0.6	6	0	0	0												
	10	1.0	1	0	0	1												
	16	1.6	1	6	0	1												
	25	2.5	2	5	0	1												
	40	4.0	4	0	0	1												
	60	6.0	6	0	0	1												
	100	10	1	0	0	2												
	160	16	1	6	0	2												
	250	25	2	5	0	2												
	400	40	4	0	0	2												
	600	60	6	0	0	2												
	100		1	0	0	3												
	160		1	6	0	3												
	250		2	5	0	3												
	400		4	0	0	3												
	600		6	0	0	3												
	-1 ... 0		X	1	0	2												
	customer		9	9	9	9											consult	
Design																		
	side display									K	H							
	45° display									K	4						consult	
Analogue output																		
	without										0							
	4 ... 20 mA / 2-wire										1							
	4 ... 20 mA / 3-wire, adjustable										7J							
	intrinsic safety 4 ... 20 mA / 2-wire ¹										E							
	customer										9						consult	
Contact																		
	1 contact											1						
	2 contacts ¹											2						
Accuracy																		
	0.5 % FSO											5						
	customer											9					consult	
Electrical connection																		
	male plug M12x1 (5-pin) / metal version											N	1	1				
	customer											9	9	9			consult	
Mechanical connection																		
	G1/2" DIN 3852											1	0	0				
	G1/2" EN 837											2	0	0				
	G1/4" DIN 3852											3	0	0				
	G1/4" EN 837											4	0	0				
	G1/2" DIN 3852 with semi-flush sensor ²											F	0	0				
	G1/2" DIN 3852 open pressure port											H	0	0				
	1/2" NPT											N	0	0				
	1/4" NPT											N	4	0				
	customer											9	9	9			consult	
Seal																		
	FKM															1		
	EPDM ³															3		
	customer															9	consult	
Pressure port																		
	stainless steel 1.4404 (316L)															1		
	PVDF ⁴															B		
	customer															9	consult	
Diaphragm																		
	ceramics Al ₂ O ₃ 96%															2		
	customer															9	consult	
Special version																		
	standard															0	0	0
	oxygen application ⁵															0	0	7
	customer															9	9	9

¹ with IS version max. 1 contact is possible

² G1/2" flush up to 60 bar and nominal pressure abs. on request

³ possible for nominal pressure ranges p_N ≤ 160 bar

⁴ PVDF only with G1/2" DIN 3852 open pressure port (up to 60 bar); Ex-protection not possible; permissible medium temperature: -30 ... 60 °C

⁵ oxygen application with FKM-seal up to 25 bar possible